

# Cold counters with basin PAB 2040

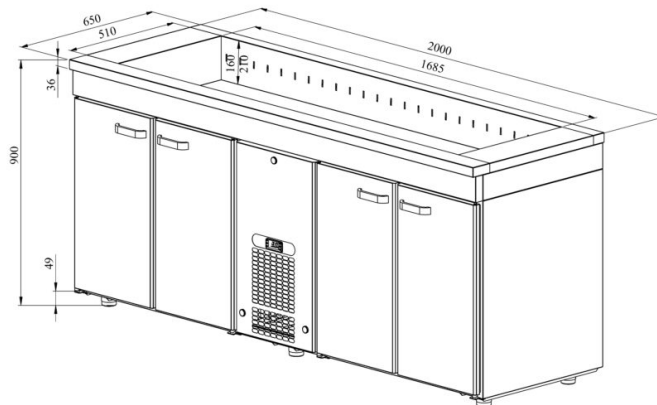

- **Product code:** PAB 2040
- **Dimensions, mm (w\*d\*h):** 2000x650x900
- **Operating temperature:** +2 .... +8
- **Degree of protection:** IP44
- **Refrigerant:** R290
- **Capacity (kW):** 0,6
- **Frequency (Hz):** 50
- **Voltage (V):** 220 - 230



- cold counter is intended for storage of foodstuffs and beverages at +2 °C to +8 °C
- made of stainless steel
- digital temperature display
- automatic defrost system
- quickly replaceable refrigerating compressor
- worktop has cold basin for bottles, fits GN 1/1-150 (5 pcs)
- counter has 8 pairs of rails for GN containers or shelves (see the gallery)
- adjustable feet allow adjusting height in the range of 855–915 mm

[Technical drawing, PDF-file](#)